

Applies only to products with serial number 20220161001 and later

EN

OWNER'S MANUAL

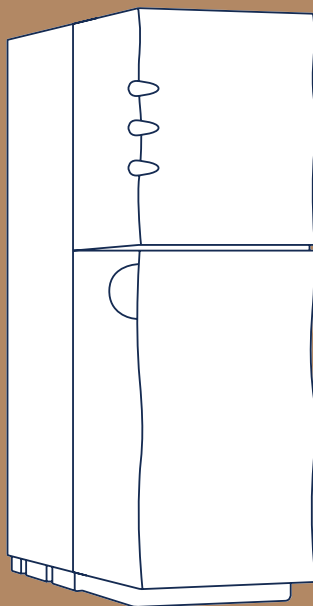

BLUEWATER SPIRIT

WATER PURIFIER



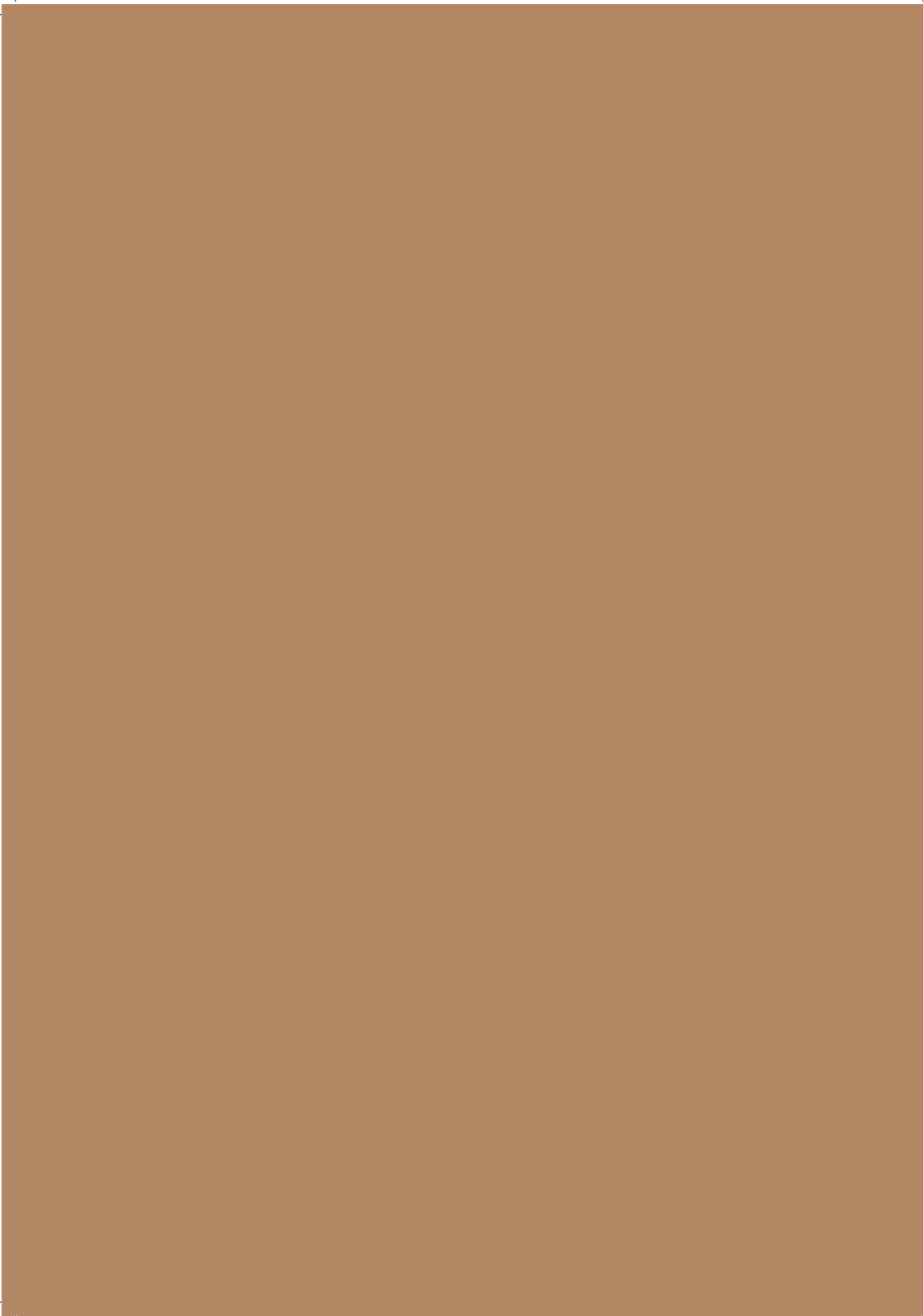

CONTENTS

SAFETY	04
Safety instructions	04
Safety information	05
PRODUCT OVERVIEW	06
Models	06
Spirit outside	06
Spirit inside and replacement components	06
Control panel	07
SYSTEM OVERVIEW	8
System description	8
Intended use	8
Installation	9
Leak protection system	9
Low pressure protection	9
Water production	10
MAINTENANCE	12
Daily maintenance	12
Regular maintenance	12
TECHNICAL INFORMATION	13
TROUBLESHOOTING	14
Troubleshooting	15

Customer service

See "Troubleshooting" to solve minor problems before calling service support.

If you need service support, be sure to have the following data (found on the data plate located behind the filter) available when calling your Bluewater dealer:

- Model
- Product number
- Serial number

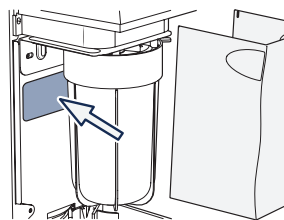

Environment information



The water purifier is more efficient when purifying water for longer periods.
Example: Filling several liters is more efficient per liter than filling just one liter at a time.



80% of the water purifier components and packaging are labeled to help you recycle and discard correctly.



Appliances bearing this symbol must be deposited at the designated local reception point for the disposal of electrical and electronic equipment. This product may not be disposed of using the normal household refuse collection processes.

SAFETY

Safety instructions

Before you install or operate the device, you must read the safety information. Obey the instructions in this manual to prevent injuries, or damage to the equipment. This manual contains CAUTIONS and NOTES that are applicable for the safe operation of the device.

 A CAUTION symbol identifies conditions that can cause injury, or damage to the equipment.
DO NOT USE Spirit unless all cautionary conditions listed below have been understood and met.

 A NOTE symbol identifies important information for trouble free and optimal use of the water purifier.

Safety information

 Be aware! If the SERVICE light is On or Flashing when the purified water faucet is turned on, do not use or drink the water. Let the water run until the SERVICE light goes out. If the SERVICE light is still On after 120 seconds, see "Troubleshooting."

 This appliance can be used by children who are more than 8 years old. It can also be used by persons with reduced physical, sensory, or mental capabilities or lack of experience and knowledge, if they have been given supervision or instruction about the use of the appliance in a safe way and understand the hazards involved.

 Do not repair or modify parts of the water purifier. This can make it operate incorrectly and lead to injury and damage not covered by warranty.

 Spirit is a reverse osmosis system. It contains a replaceable membrane that is very important for effective reduction of total dissolved solids (TDS). Replace this membrane regularly. Test the purified water periodically using a TDS/Conductivity tester at least one time every year to make sure that Spirit performs correctly. For options, contact your Bluewater dealer. If there is any indication that the purified water tastes, smells bad, is cloudy, or there is a presence of particles, do not drink.





 We recommend only approved technicians, distributors or Bluewater service personnel perform installations, servicing and repairs on the water purifier. If not performed adequately, this can make it operate incorrectly, and lead to injury and damage not covered by warranty.

 Only use original replacement cartridges and parts from Bluewater. For the spare parts catalogue, see www.bluewatergroup.com. For purchase information, contact your Bluewater dealer.

 The inlet water must meet the requirements stated in "REQUIREMENTS FOR INLET WATER to water purifier."

 Installation must comply with applicable local plumbing codes and regulations.

 Connect the water purifier to an earthed/grounded electrical supply. Use a plug that is easy to access after installation. Only an approved electrician must do permanent wiring on the system. Incorrect installation can lead to damage or make the water purifier dangerous to use.

 Do not use Spirit without the filter. This can cause damage to the system. The filter can be removed when Spirit is cleaned or put into storage.

 If the water purifier is disconnected from water and electricity for >5 days, store it as described in Complete User manual "Put into storage."

 Contact your Bluewater dealer for advice before moving the water purifier from one place to another.

PRODUCT OVERVIEW

Models

Model	Description
Spirit 300Cp	Pressure controlled, compatible with faucets and appliances approved for Reverse Osmosis purified water.

Spirit outside

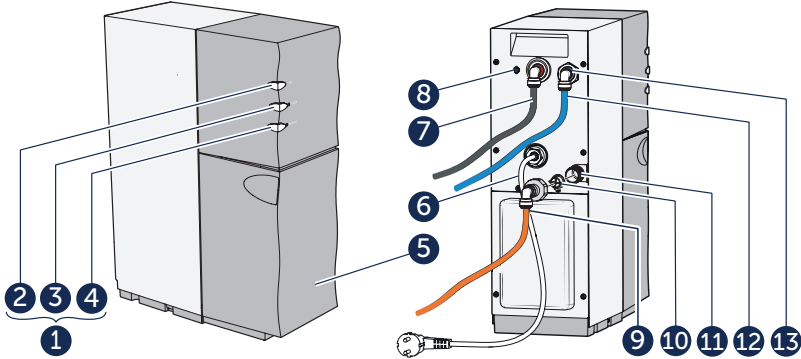
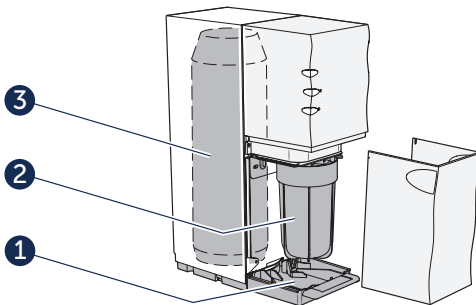

Figure 1. Spirit outside

Pos	Description	Pos	Description
1	Control panel	8	Bluewater LED faucet connection
2	ON light	9	Inlet water tube and fittings
3	FILTER light	10	Inlet Grid Filter
4	SERVICE light	11	Inlet water connection
5	Front cover	12	Purified water tube
6	Power cord	13	Purified water connection
7	Drain water tube		

Spirit inside and replacement components



Pos	Description	Art. no
1	Base plate	
2	Prefilter, Carbon filter, granulated	919240004
3	Reverse osmosis membrane	
	Membrane service kit, type HR (High Rejection)	155007301-SP
	Membrane service kit, type HF (High Flow)	150759380-SP

Figure 2. Spirit inside

Control panel

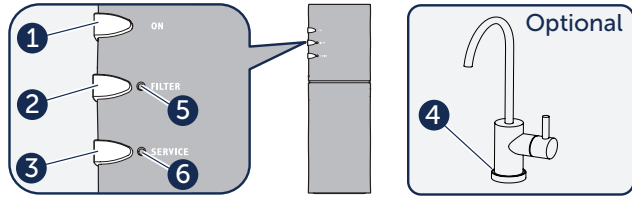















Figure 3. Control panel

Pos	Light/Button	Description
1	ON light	On:  The water purifier is connected and operates correctly. Flashes slowly: The water purifier is busy flushing the membrane. Flashes quickly:  See "Troubleshooting."
2	FILTER light	Off:  Filter and inlet water pressure are OK. Flashes slowly:  Flashes quickly:  On:  See "Troubleshooting."
3	SERVICE light	Off:  Water quality is OK. Flashes slowly:  Water quality is decreased.* Flashes quickly:  See "Troubleshooting." On:  Water quality is not OK. Do not drink.* *If the SERVICE light is On or Flashing, let the water run up to 120 seconds until the SERVICE light goes out. If the water purifier stops or continues Flashing, see "Troubleshooting."
4	Bluewater LED faucet lights (Optional)	Blue:  Water quality is OK. Orange:  The water is not yet ready to drink. This can take up to 120 seconds. Blue flashes:  The water purifier is busy flushing the membrane. Flashes orange:  The water purifier needs attention. Look at the control panel.
5	FILTER Button	
6	SERVICE Button	

 For information about combinations of lights that Flash or are On, see "Troubleshooting."

SYSTEM OVERVIEW

System description

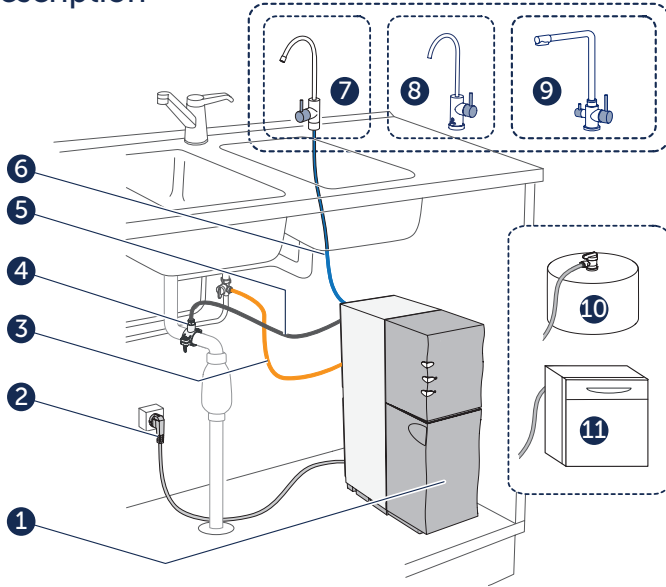



Figure 4. System overview, an example of a Spirit installation

Pos	Description	Pos	Description
1	Water purifier	4	Drain saddle connection
2	Power cord	5	Drain water tube
3	Inlet water tube	6	Purified water tube
Pos	Accessories	Description	
7	Standard RO faucet	Approved for use with Reverse Osmosis purified water.	
8	Bluewater LED faucet	LED indicates service and purified water quality notifications.	
9	Bluewater Triflow faucet	Provides purified water in addition to hot and cold non purified water.	
10	Storage tank	Use only tanks approved for use with Reverse Osmosis purified water.	
11	Appliance	Dishwasher, coffee machine, ice maker, refrigerator, etc. Appliances must be approved for use with Reverse Osmosis purified water.	

Intended use

The Spirit water purifier is intended to produce purified water only for home environment and household use. Any other purpose shall be considered as unintended use and will automatically void your warranty, unless the application is approved, installed, and monitored by a Bluewater authorized distributor or dealer.

Installation

 Spirit must supply purified water directly to a faucet or storage tank designed for reverse osmosis purified water. The purified water must not travel through any non approved pipes or faucets because this can cause corrosion damage.

 Installation must comply with applicable local plumbing codes and regulations.

 Only connect the water purifier to the cold water supply. The water must be of sufficient quality and meet the "REQUIREMENTS FOR INLET WATER to water purifier."

If the Spirit is not installed correctly, it will not be covered under warranty.

The first time Spirit is connected to water and power, the INSTALLER MUST initiate a Commissioning Flush. This 36 minute flush is a VERY IMPORTANT flush and must be allowed to continue to completion. Keep the Spirit connected to power, with the purified water faucet open for the entire time. Do not interrupt this flush. Do not drink the water until this flush is complete. See Complete User Manual for instructions on the Commissioning Flush.

 We recommend that the water purifier be installed by a Bluewater dealer. Installation instructions can be found in the Complete User manual and on www.bluewatergroup.com.

Leak protection system

A sensor at the bottom of the water purifier senses water leaks. If there is a leak, the inlet water supply is stopped. The water purifier cannot be started again until the leak has been repaired.

Low pressure protection

 If Spirit stops because of low inlet water pressure, the cause of the low inlet water pressure must be resolved.

Low pressure restart function

The low pressure restart is a function to ensure maximum availability of water. If Spirit has stopped due to low inlet water pressure, Spirit attempts to restart automatically and continues restart attempts every 5 minutes, for up to 10 times. If the low inlet pressure problem is not resolved by the 10th restart attempt, Spirit will stop. Once the low inlet pressure has been resolved, Spirit can be restarted manually by pressing the SERVICE Button for 5 seconds.

Water production

Be aware! If the SERVICE light is On or Flashing when the purified water faucet is turned on, do not use or drink the water. Let the water run until the SERVICE light goes out. If the SERVICE light is still On after 120 seconds, see "Troubleshooting."

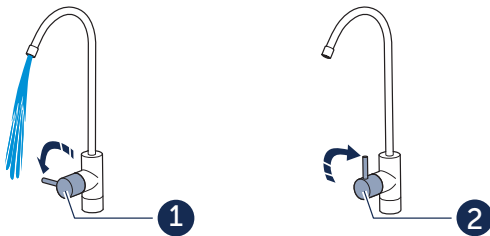

Figure 5. Purified water production on/off

Automatic flush



The length of each of these three flushes is 2.5 minutes.

An automatic flush will be performed if one of the conditions below is met:

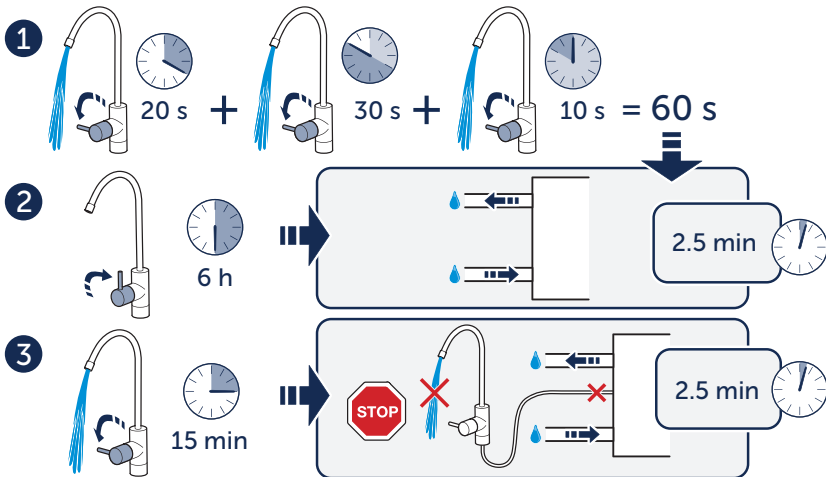

Figure 6. Automatic flush

Pos	Description
1	Automatic Flush takes place after purified water has been produced for a total of 60 seconds and the purified water faucet is turned off.
2	Automatic Flush takes place every 6 hours, while the Spirit is in standby mode.
3	Automatic Flush takes place after purified water has been produced for a total of 15 minutes. This flush cannot be interrupted. Purified water will be available after this flush completes.

MAINTENANCE

Daily maintenance

Check indicator lights

Step	Action
1	Check the FILTER and SERVICE lights. If either or both lights are On or Flashing, see "Troubleshooting."

Clean the water purifier

 Do not use chemicals to clean the surface. Alcohol, petrol, organic and inorganic acids, strong basic chemicals (such as concentrated dishwashing detergent) will cause damage to the surface.

 Do not use hard, sharp or abrasive tools to clean the water purifier.

Step	Action
1	Clean the outer surface with a soft, moist cloth and a weak soap solution to remove dust, stains, and dirt.
2	Dry with a soft dry cloth.

Regular maintenance

 Regular maintenance is important for correct function and long term operation. We recommend only Bluewater approved service personnel perform maintenance and repairs.

 For instructions on how to do maintenance, see Complete User manual on www.bluewatergroup.com.





Frequency	Description
1 month	Check connections Wipe off condensation from the base plate.
4-6 months*	Replace the filter every 4–6 months or as indicated by the FILTER light.
6 months*	Descale
1 year	Test the purified water every year using a TDS/Conductivity tester. If the purified water is not clean, do not drink it. Contact your Bluewater dealer.
3–5 years*	Replace reverse osmosis membrane. Contact your Bluewater dealer.

*Frequency depending on water quality and usage

TECHNICAL INFORMATION

Parameter	
Size WxDxH [mm (inches)]	150x365x462 (5.9x14.3x18.2)
Weight [kg (lbs)]	15 (33)
Power supply, earthed supply Power supply, earthed supply US	220-240V 50/60 Hz, 10A 120V 60 Hz, 10A
Power (US)	350W (3Amps)
Faucet with purified water quality indicator light	Optional
Compatible with Reverse Osmosis approved household appliances	✓

REQUIREMENTS FOR INLET WATER to water purifier

-  Do not use with water that is microbiologically unsafe or of unknown quality without adequate disinfection before or after the system.
-  Only connect to the cold water supply. The temperature limits are in the table below.
-  If the inlet water quality changes greatly, contact your Bluewater dealer for advice.
-  For more detailed technical information see www.bluewatergroup.com

Description	
Temperature [°C (°F)]	2–35 (36–95)
Inlet water flowing pressure [kPa (bar) (psi)]	150 –1000 kPa (1.5 –10 bar) (22–145 psi)
TDS/PPM (Total Dissolved Solids)	< 1200
Inlet water flow [l/min (gal/min)]	> 6 (1.6)
Conductivity $\mu\text{S/cm}$ @ 25°C (77°F)	< 1600
Hardness [°dH (grains per gallon)]	< 10 °dH (< 10.4 gpg)
Turbidity (FNU)	<0.5 FNU
Iron Fe(II) / Fe(III) (mg/l)	< 0.5 / < 0.3 mg/l
pH	6 - 9
Manganese (Mn ²⁺)	<0.3 mg/l
Chlorine (Cl ₂)	<1.0 mg/l

TROUBLESHOOTING



For more severe problems, see Complete User manual on bluewatergroup.com

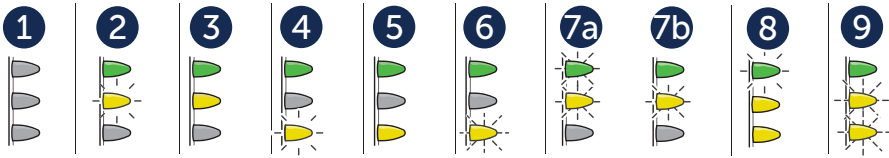

Symptom	Cause	Solution
1 The ON light is not on.	The water purifier is not connected to power.	Connect the water purifier to power.
2 The FILTER light is Flashing slowly.	The filter must be replaced.	See Complete User manual.
3 The FILTER light is on.	The filter replacement time has lapsed. The filter should be replaced.	See Complete User manual.
4 The SERVICE light is Flashing slowly after 30 seconds.* *It is normal for the SERVICE light to Flash slowly for the first 30 seconds each time the purified water faucet is turned on.	If the SERVICE light continues Flashing slowly beyond 30 seconds, this indicates that the purified water quality has decreased. The purified water is still safe to drink.	Contact your Bluewater dealer to replace the RO membrane.
5 The SERVICE light is on.	The water quality is initially decreased during purification. Do not drink the water yet.	Wait for up to 120 seconds for the SERVICE light to go off before drinking. If the water purifier stops, contact your Bluewater dealer. If the Service light changes and begins Flashing slowly, refer to condition 4 above and contact your Bluewater dealer.
	The water purifier has stopped. A recent filter replacement may have introduced air into the system, causing a sensor malfunction.	Disconnect the water purifier from power. Reconnect it. Let the water purifier do the automatic flush.
	The water purifier has stopped. The clean water quality has become too low.	Contact Bluewater to replace the RO membrane.
6 The SERVICE light is Flashing quickly.	The inlet water or purified water quality sensors are not functioning correctly.	Wait for up to 120 seconds for the SERVICE light to go off before drinking. If the water purifier stops or continues Flashing, contact your Bluewater dealer.

Symptom		Cause	Solution
7a	The ON light and the FILTER light are Flashing quickly.	The inlet water low pressure restart function is active.	See Complete User manual.
7b	The water purifier makes noise, or the FILTER light is Flashing quickly while the ON light is On. This is due to low inlet water pressure.	The Inlet Grid Filter is blocked.	See Complete User manual.
		The prefilter is blocked.	See Complete User manual.
		The inlet pressure was lower than 1.5 bar (22 psi) during operation.	If the water purifier stops, contact your Bluewater dealer.
8	The ON light is Flashing slowly. The FILTER light and SERVICE light are On.	The faucet is not completely closed.	Close the faucet.
		There is a small leakage inside or outside the water purifier.	See Complete User manual.
9	The FILTER light and the SERVICE light are Flashing quickly.	The leakage overflow protection system is activated.	Disconnect the water purifier from power and clean the base plate. If the overflow protection is activated again, contact your Bluewater dealer.
	The flow rate from the purified water faucet is low.	The water purifier needs to be descaled.	See Complete User manual.
		The purified water tubing has been sharply bent or blocked.	Make sure that there are no sharp bends in the purified water tubing and that it can move freely.
	Water does not flow from the purified water faucet.	The inlet water shut-off valve is closed.	Open the inlet water shut-off valve.
	The water from the water purifier smells bad.	Possible Microbial (bacterial) growth in the water purifier due to the water purifier not being used for a long period of time.	Spirit may need to be disinfected. See Complete User manual.



Enjoy your **BLUEWATER SPIRIT!**
One of the best water purifiers in the world!

**FOR YOU &
OUR PLANET**



Scan for Manual



Bluewater is a world leading water purification company. Headquartered in Stockholm, Sweden, the company helps people and businesses globally enjoy the health and wellbeing benefits of cleaner, healthier tap water.

Bluewater innovates, makes, and sells compact water purifiers that harness the company's patented reverse osmosis technology to remove virtually all pollutants from tap water, including lead, bacteria, pesticides, medical residues, chlorine, and limescale.

Please visit us at www.bluewatergroup.com



BLUEWATER

Danderydsgatan 11
SE-114 26 Stockholm
Sweden
E: info@bluewatergroup.com

www.bluewatergroup.com

